

ANALOG CONTEMPORARY SERIES

CTM-A2415
Cordless 1-line Hotel Phone

CTM-A2415HC
Cordless Accessory Handset and Charging Base

vtech[®]

Master User 's Guide

IMPORTANT SAFETY INSTRUCTIONS

When using your telephone equipment, basic safety precautions should always be followed to reduce the risk of fire, electric shock and injury, including the following:

1. This product should be installed by a qualified technician.
2. This product should only be connected to the host equipment and never directly to the network such as Public Switch Telephone Network (PSTN) or Plain Old Telephone Services (POTS).
3. Read and understand all instructions.
4. Follow all warnings and instructions marked on the product.
5. Unplug this product from the wall outlet before cleaning. Do not use liquid or aerosol cleaners. Use a damp cloth for cleaning.
6. Do not use this product near water such as near a bath tub, wash bowl, kitchen sink, laundry tub or swimming pool, or in a wet basement or shower.
7. Do not place this product on an unstable table, shelf, stand or other unstable surfaces.
8. Slots and openings in the back or bottom of the telephone base and handset are provided for ventilation. To protect them from overheating, these openings must not be blocked by placing the product on a soft surface such as a bed, sofa or rug. This product should never be placed near or over a radiator or heat register. This product should not be placed in any area where proper ventilation is not provided.
9. This product should be operated only from the type of power source indicated on the marking label. If you are not sure of the type of power supply on the premises, consult your dealer or local power company.
10. Do not allow anything to rest on the power cord. Do not install this product where the cord may be walked on.
11. Never push objects of any kind into this product through the slots in the telephone base or handset because they may touch dangerous voltage points or create a short circuit. Never spill liquid of any kind on the product.
12. To reduce the risk of electric shock, do not disassemble this product, but take it to an authorized service facility. Opening or removing parts of the telephone base or handset other than specified access doors may expose you to dangerous voltages or other risks. Incorrect reassembling can cause electric shock when the product is subsequently used.
13. Do not overload wall outlets and extension cords.
14. Unplug this product from the wall outlet and refer servicing to an authorized service facility under the following conditions:
 - When the power supply cord or plug is damaged or frayed.
 - If liquid has been spilled onto the product.
 - If the product has been exposed to rain or water.
 - If the product does not operate normally by following the operating instructions. Adjust only those controls that are covered by the operation instructions. Improper adjustment of other controls may result in damage and often requires extensive work by an authorized technician to

restore the product to normal operation.

- If the product has been dropped and the telephone base and/or handset has been damaged.
- If the product exhibits a distinct change in performance.

15. Avoid using a telephone (other than cordless) during an electrical storm. There is a remote risk of electric shock from lightning.

16. Do not use the telephone to report a gas leak in the vicinity of the leak. Under certain circumstances, a spark may be created when the adapter is plugged into the power outlet, or when the handset is replaced in its cradle. This is a common event associated with the closing of any electrical circuit. The user should not plug the phone into a power outlet, and should not put a charged handset into the cradle, if the phone is located in an environment containing concentrations of flammable or flame-supporting gases, unless there is adequate ventilation. A spark in such an environment could create a fire or explosion. Such environments might include: medical use of oxygen without adequate ventilation; industrial gases (cleaning solvents; gasoline vapors; etc.); a leak of natural gas; etc.

17. Only put the handset of your telephone next to your ear when it is in normal talk mode.

18. The power adapters are intended to be correctly oriented in a vertical or floor mount position. The prongs are not designed to hold the plug in place if it is plugged into a ceiling, under-the-table or cabinet outlet.

19. Use only the power cord and batteries indicated in this manual. Do not dispose of batteries in a fire. They may explode. Check with local codes for possible special disposal

instructions.

20. In wall mounting position, make sure to mount the telephone base on the wall by aligning the eyelets with the mounting studs of the wall plate. Then slide the telephone base down on both mounting studs until it locks into place. Refer to the full instructions in Installation in the user's manual.

CAUTIONS

- Keep small metallic objects such as pins and staples away from the handset receiver;
- Risk of explosion if battery is replaced by incorrect type;
- Disposed of used batteries according to the instruction;
- Disconnect the telephone line before replacing batteries;
- Avoid to use battery in following conditions:-
 - High or low extreme temperatures that a battery can be subjected to during use, storage or transportation;
 - Low air pressure at high altitude;
 - Replacement of a battery with an incorrect type that can defeat a safeguard;
 - Disposal of a battery into fire or a hot oven, or by mechanically crushing or cutting of a battery, that can result in an explosion;
 - Leaving a battery in an extremely high temperature surrounding environment that can result in an explosion or the leakage of flammable liquid or gas;
 - Extremely high temperature and/or extremely low air pressure that can result in an explosion or the leakage of

flammable liquid or gas.

- For pluggable equipment, the socket-outlet (power adaptor) shall be installed near the equipment and shall be easily accessible;
- The equipment is only use for mounting at height <2M; and
- The applied nameplate is located at the bottom.

SAVE THESE INSTRUCTIONS

TABLE OF CONTENTS

Important safety instructions 2

Parts check list 6

Telephone layout 7

Cordless 1-line CTM-A2415 Base 7

Cordless 1-line CTM-A2415 and CTM-A2415HC
Handset 8

Cordless 1-line CTM-A2415HC Charging Stand
9

Installation 9

Cordless 1-line - CTM-A2415 9

Connection 12

Cordless 1-line - CTM-A2415 12

Cordless Accessory Handset & Charging stand
- CTM-A2415HC 13

Set up 14

Cordless 1-line - CTM-A2415 14

Cordless Accessory Handset & Charging stand
- CTM-A2415HC 14

Operation 17

Cordless 1-line - CTM-A2415 17

Cordless Accessory Handset & Charging stand
- CTM-A2415HC 17

Appendix 19

CTM-A2415 Base backup battery 19

CTM-A2415HC Handset battery 19

Appendix 20

Troubleshooting 20

Appendix 27

VTech Hospitality Limited Warranty Program
27

Appendix 29

Energy-saving charging mode 29

Maintenance 29

Disclaimer and Limitation of Liability 30

European Directives 30

Disposal of batteries and product 30



Technical specification 31

Cordless 1-line - CTM-A2415 31

Cordless Accessory Handset & Charging Stand
- CTM-A2415HC 31

Parts check list

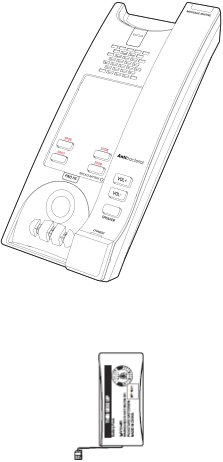
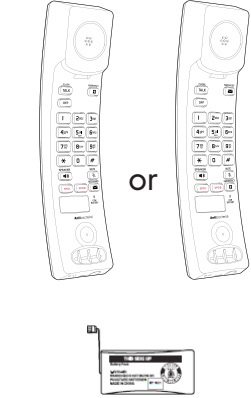
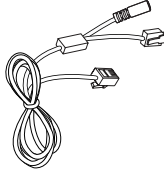
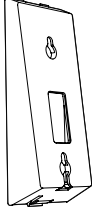
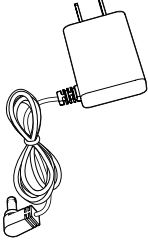
Items contained in the respective **cordless telephone** package:

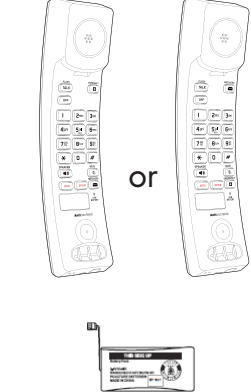
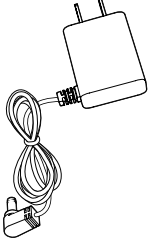
MODEL NAME	MODEL NUMBER	PARTS INCLUDED				
		TELEPHONE BASE WITH FACEPLATE AND OVERLAY CHARGING BASE	CORDLESS HANDSET AND HANDSET BATTERY	TELEPHONE LINE CORD WITH POWER CONNECTOR	BASE STAND WALL MOUNT BRACKET	POWER ADAPTER
Cordless 1-line	CTM-A2415					
Cordless 1-line accessory handset & charging base	CTM-A2415HC			--	--	

Telephone layout

Cordless 1-line CTM-A2415 Base

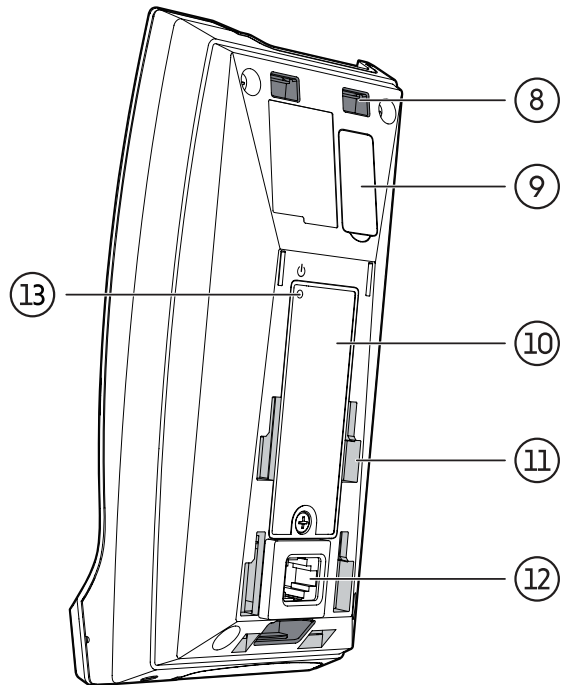
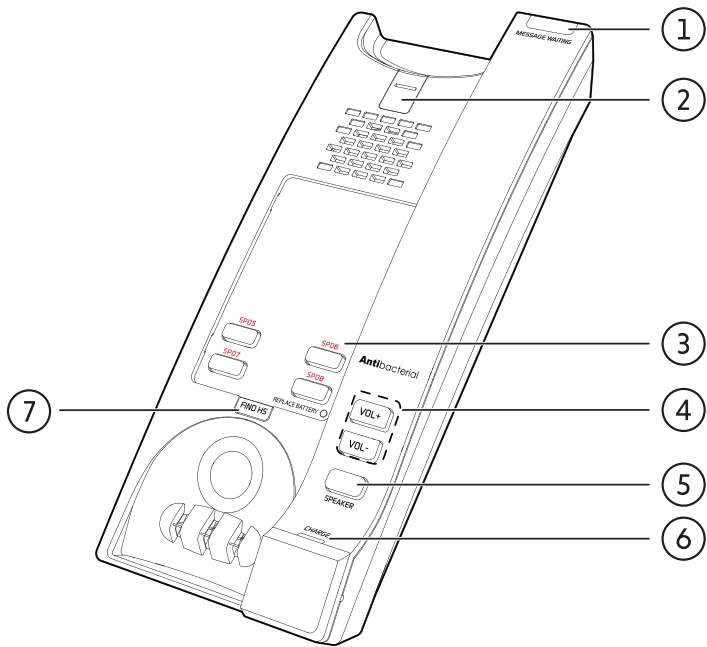

1	MESSAGE WAITING LED
2	Wall mount clip
3	Faceplate slot with Speed dial keys (Programmable)
	SPD5
	SPD6
	SPD7
	SPD8
	REPLACE BATTERY LED
4	VOL + VOL - (VOLUME +/-)
5	SPEAKER
6	CHARGE LED
7	FIND HS (FIND HANDSET)
8	Grooves for Mounting bracket
9	Voicemail voltage detection
10	Battery compartment with cover
11	Grooves for Base stand
12	Telephone jack
13	Base battery ON pinhole

Cordless 1-line CTM-A2415 and CTM-A2415HC Handset

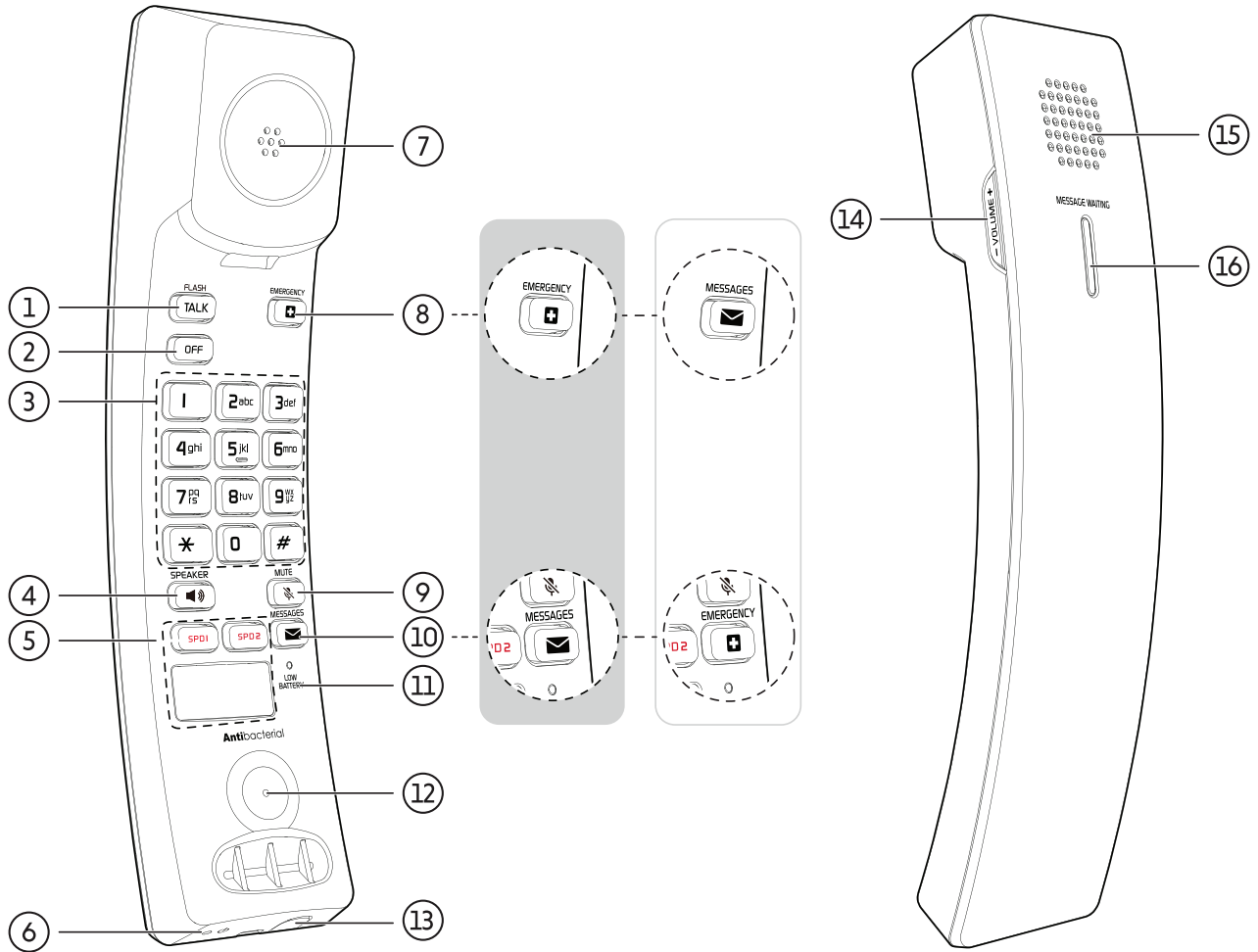

1	TALK FLASH
2	OFF
3	Numeric dial keys
4	SPEAKER 🗣️
5	Speed Dial keys (Programmable)
	SPD1
	SPD2
6	Handset battery ON pinhole
7	Handset earpiece
*8	EMERGENCY 🚑 (Programmable)
	MESSAGES 📧 (Programmable)
9	MUTE 🤐
*10	MESSAGES 📧 (Programmable)
	EMERGENCY 🚑 (Programmable)
11	LOW BATTERY LED
12	Microphone
13	Handset screw cover
14	-/VOLUME/+

15	Speakerphone
16	MESSAGE WAITING LED

*Design is subject to change without prior notice.

Cordless 1-line CTM-A2415HC Charging Stand

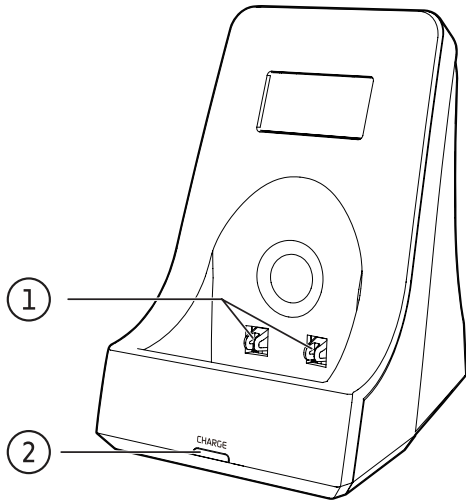

1	Charging poles
2	CHARGE LED

Installation

Cordless 1-line - CTM-A2415

INSTALLATION OPTION - INSTALL BASE STAND FOR DESKTOP

TO MOUNT THE BASE STAND

1. Align the grooves with the base stand.
2. Slide down to secure the stand.

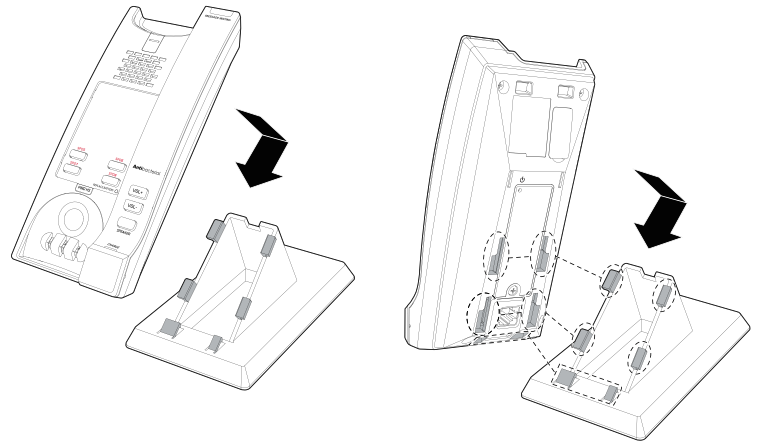

TO UNMOUNT THE BASE STAND

Simply slide up and lift the telephone base from the base stand.

INSTALLATION OPTION - CONVERTING FROM DESKTOP TO WALL MOUNT POSITION TO MOUNT THE TELEPHONE BASE ON THE WALL

1. Unmount the base stand. Put the cordless handset aside. On the telephone base, press the wall mount clip upward and rotate a half turn (180°). Slide back the clip.

- It locks into place with the protruding edge pointing towards the upper edge of the telephone base. This protruding edge holds the cordless handset when the phone is mounted on the wall.

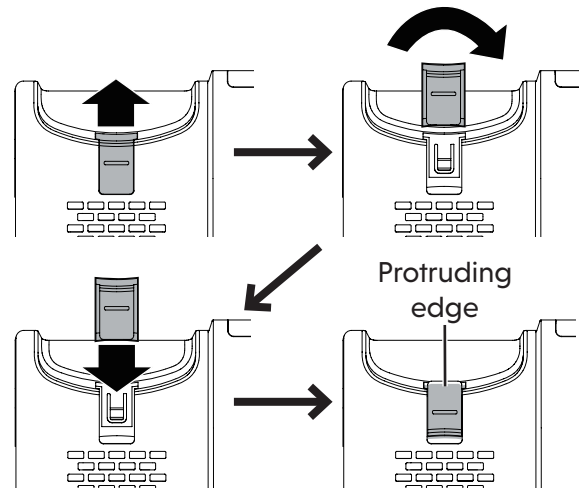

2. Turn the telephone base over with the bottom side facing up. Press the tabs of the mounting bracket as the direction indicated into the grooves on the telephone base until they lock securely.

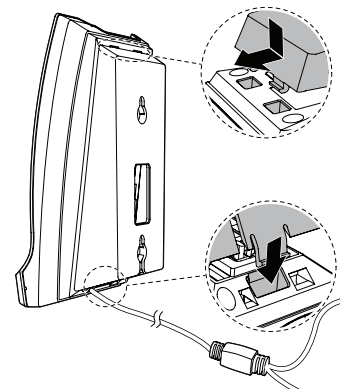
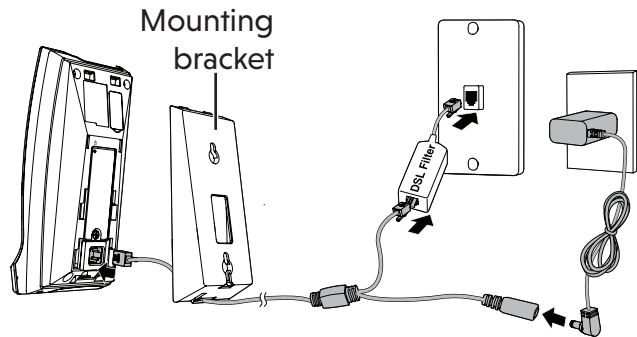

3. Mount the telephone base on the wall by positioning the eyelets on the telephone base and the mounting bracket against the mounting studs. Then slide the telephone base down on both mounting studs until it locks into place.

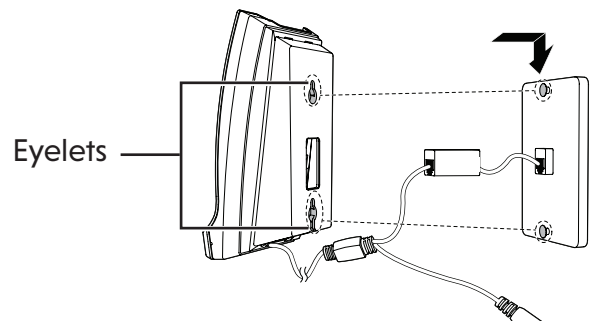

4. Replace the handset on the telephone base cradle.

REPLACE TELEPHONE BASE BATTERY INSTALLATION

The telephone base battery is pre-installed. To replace the telephone base battery, follow as shown below.

1. Remove the screw with cross head screwdriver. Gently open the battery compartment cover.

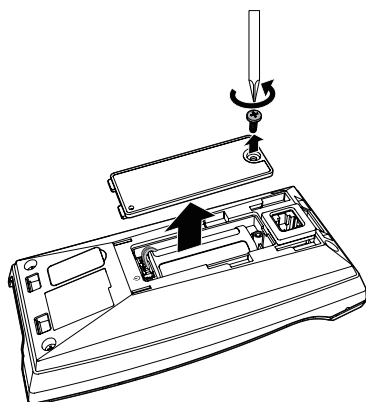

2. Remove the used battery from the compartment. Plug the new battery connector securely into the socket inside the base battery compartment. Place the battery with the label **THIS SIDE UP** facing up and the wires inside the battery compartment.

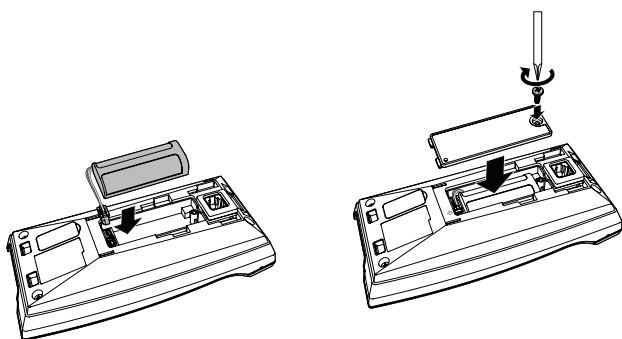

3. To replace the handset cover, align all the tabs on the base compartment battery cover against the corresponding grooves, then install the screw.

REPLACE A HANDSET BATTERY INSTALLATION

The handset battery is pre-installed. To replace the handset battery, follow as shown below.

1. Use a narrow object to pry open the screw cover and remove the screw with cross head screwdriver. Then, insert a 5 mm standard flat head screwdriver in the provided slot and gently open the handset cover.

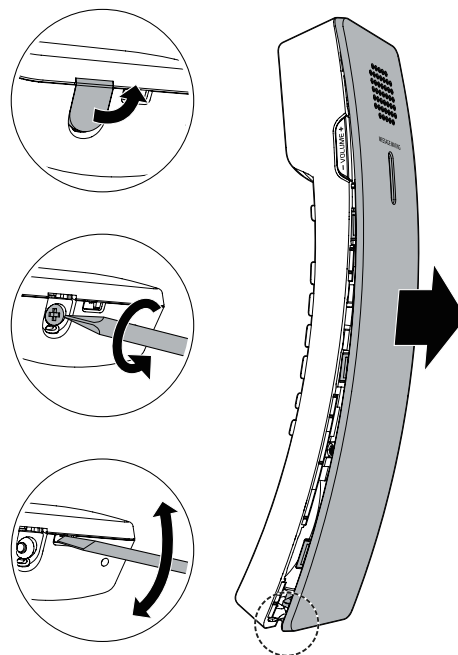

2. Unplug the battery connector from the socket and then remove the battery from the handset battery compartment.

3. Plug the battery connector securely into the socket inside the handset battery compartment. Place the battery with the label **THIS SIDE UP** facing up and the wires inside the battery compartment.

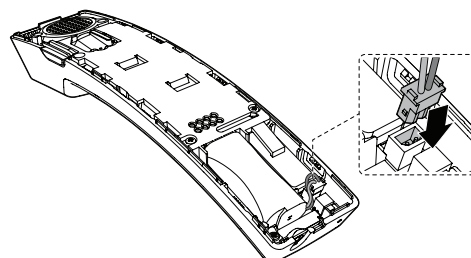

4. To replace the handset cover, align all the tabs on the handset cover against the corresponding grooves on the handset, then firmly push downward until all the tabs lock in the grooves. Then install the screw.

Connection

Cordless 1-line - CTM-A2415

TELEPHONE BASE INSTALLATION

The telephone comes ready for desktop use.

1. Install the telephone base as shown below.

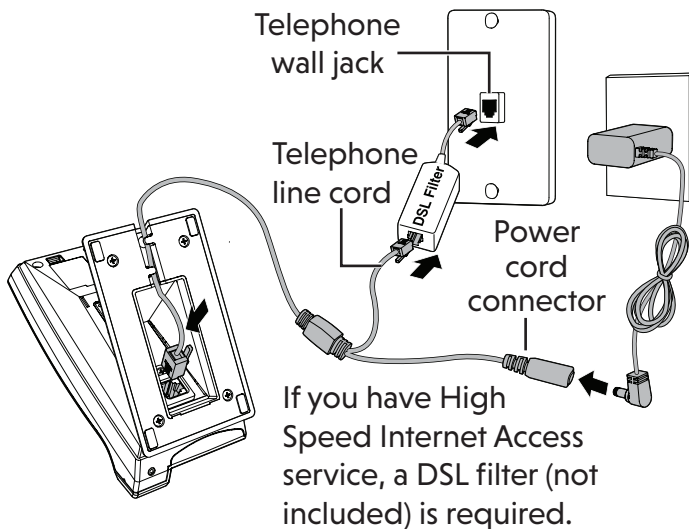

2. When the telephone base has been initially installed, make sure the power adapter is securely plugged into an outlet not controlled by a wall switch, and the telephone line cord is plugged firmly into the power adapter and the telephone wall jack.

3. Bend a small paperclip and gently insert it to the Base battery ON pinhole and Handset battery ON pinhole to turn on the base and the handset.

- Without turning on the battery, the base and the handset cannot be charged.
- Charge the base to enable battery backup feature.
- The battery is fully charged after 12 hours of continuous charging. For best performance, keep the cordless handset in the telephone

base when not in use.

4. Press **SPEAKER** on the telephone base. Listen for a dial tone, and then press **SPEAKER** again to hang up.

⚠ CAUTION

Use only the supplied cable and power adapter. The supplied cable is not designed for use in any other IT devices. Misuse it on your other IT devices shall be prohibited. To order a replacement, call 1-888-907-2007.

Cordless Accessory Handset & Charging stand - CTM-A2415HC

CHARGER BASE INSTALLATION

The telephone comes ready for desktop use.

1. Install the charger base as shown below.
 - Make sure the power adapter is securely plugged into an outlet not controlled by a wall switch.

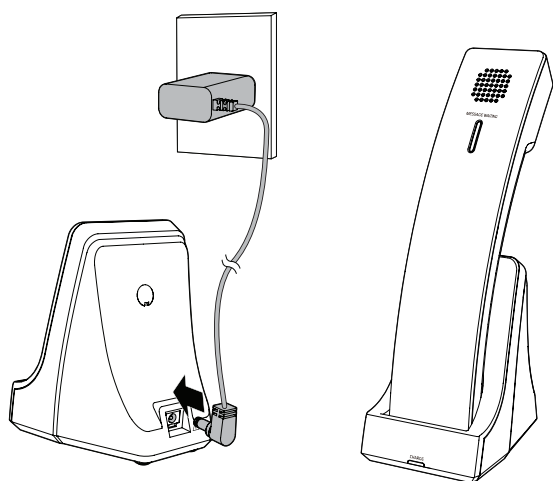

2. Bent a small paperclip and gently insert it to the Handset battery ON pinhole to turn on the handset.

- Without turning on the battery, the handset cannot be charged.
- The battery is fully charged after 12 hours of continuous charging. For best performance, keep the cordless handset in the charging base when not in use.

3. Press **[SPEAKER]** on the handset. Listen for a dial tone, and then press **[SPEAKER]** again to hang up.

⚠ CAUTION

Use only the supplied power adapter. The supplied power adapter is not designed for use in any other IT devices. Misuse it on your other IT devices shall be prohibited. To order a replacement, call 1-888-907-2007.

HANDSET REGISTRATION

Place the cordless handset on the telephone base cradle. Handset registration happens automatically the first time a cordless handset is placed on the telephone base.

When the registration process completes, the **MESSAGE WAITING** LED flashes once and you hear 3 rising beeps as confirmation.

Each telephone base accommodates up to 4 cordless handsets. When you already have 4 registered handsets, you can replace one of them by a new handset if any one of the 4 registered handsets is disconnected from the base. For example, it is out of range, or its battery is removed or depleted. The previous registered handset is then deregistered from the telephone base.

HANDSET DEREGISTRATION

When a registered cordless handset is idle, press ***331734#**. You hear a confirmation tone when the deregistration process completes.

REGISTER A HANDSET TO ANOTHER TELEPHONE BASE

When a registered cordless handset is idle, place it on another telephone base. This cordless handset automatically registers to the new telephone base.

HANDSET BATTERY CHARGING

The batteries must be fully charged before using the cordless base and the handset for the first time. The **CHARGE** LED turns on when the cordless handset is charging on the telephone base or charging base. The battery is fully charged after 12 hours of continuous charging. For best performance, keep the cordless handset in the telephone base or charging base when not in use.

Set up

Cordless 1-line - CTM-A2415

Cordless Accessory Handset & Charging stand - CTM-A2415HC

PROGRAM PHONE SETTINGS

In order to program different telephone settings, you have to enter **ADMIN** mode during system idle by pressing ***7764#MUTE** on the handset. You will hear 3 rising beeps as confirmation.

- During **ADMIN** mode, **MUTE** key LED on handset, the **MESSAGE WAITING** LED and **SPEAKER** LED on the base will blink.

To quit **ADMIN** mode with your settings, press **OFF** key, and you will hear 2 rising beeps to confirm. To quit **ADMIN** mode without saving your settings, press **OFF** key before entering the setting value.

PHONE SETTINGS

Default settings are indicated by asterisks (*).

Some settings have their corresponding **Access Keys** or **Access Codes**. After entering the setting value, you will hear a confirmation tone, and the **ADMIN** mode will quit.

SETTING	ACCESS CODE/ KEY	OPTIONS	ADJUSTABLE BY
Listening volume- Handset		1, 2, 3, 4*, 5, 6	User and administrator
Speakerphone volume - Handset		1, 2, 3, 4*, 5, 6	User and administrator
Speakerphone volume - telephone base		1, 2, 3, 4*, 5, 6	User and administrator
Ringer volume - telephone base		1, 2*, 3	User and administrator
Ringer tone	00	Tone 1*, Tone 2, Tone 3	Administrator only
Flash	FLASH	1 (100ms), 2 (300ms), 3* (600ms)	Administrator only
RF transmission power - telephone base	01	1 (low), 2* (middle), 3 (high)	Administrator only
Voicemail voltage detection <ul style="list-style-type: none"> • Steady high voltage, periodic high voltage pulse and periodic low voltage pulse detection method • Line reversal method • FSK detection method • Panasonic 	<ul style="list-style-type: none"> • 10 • 11 (Line rev.) • 12 (FSK) • 14 (Panasonic) 	0 (disable), 1 (enable)	Administrator only
Voicemail voltage detection <ul style="list-style-type: none"> • Siemens 	13	0 (disable), 1 (50Hz), 2 (25Hz), 3 (20Hz)	Administrator only

RINGER TONE

There are 3 ringer tone options that can be assigned to the telephone base.

TO CHANGE THE RINGER TONE

1. Press ***7764#MUTE** on the handset to enter **ADMIN** mode.
2. Press **00**. Then press a dialing key **1**, **2** or **3** to select the desired ringer tone. You hear 3 rising beeps as confirmation.

FLASH

There are 3 flash duration options that can be programmed.

TO CHANGE THE FLASH DURATION

1. Press ***7764#MUTE** on the handset to enter **ADMIN** mode.
2. Press **FLASH**. Then, press a dialing key, **1** (100ms), **2** (300ms) or **3** (600ms), to select the desired flash duration. You hear 3 rising beeps as confirmation.

RF TRANSMISSION POWER

There are 3 RF transmission power options on the telephone base that can be programmed.

TO CHANGE THE RF TRANSMISSION POWER CONTROL LEVEL

1. Press ***7764#MUTE** on the handset to enter **ADMIN** mode.
2. Press **01**. Then, press a dialing key
 - **1** (low - coverage of 25% of maximum working distance),
 - **2** (middle - coverage of 50% maximum working distance) or
 - **3** (high - coverage of 100% of maximum working distance),

to select the desired RF transmission power control level. You hear 3 rising beeps as confirmation.

VOICEMAIL VOLTAGE DETECTION

There are several voicemail voltage detection methods on the telephone base that can be programmed.

TO CHANGE THE VOICEMAIL VOLTAGE DETECTION BY THE STEADY HIGH VOLTAGE, PERIODIC HIGH VOLTAGE PULSE AND PERIODIC LOW VOLTAGE PULSE DETECTION METHOD

1. Press ***7764#MUTE** on the handset to enter **ADMIN** mode.
2. Press **10**. Then, press a dialing key, **0** (disable) or **1** (enable), to select the desired setting. You hear 3 rising beeps as confirmation.

TO CHANGE THE VOICEMAIL VOLTAGE DETECTION BY THE LINE REVERSAL METHOD

1. Press ***7764#MUTE** on the handset to enter **ADMIN** mode.
2. Press **11**. Then press a dialing key, **0** (disable) or **1** (enable), to select the desired setting. You hear 3 rising beeps as confirmation.

TO CHANGE THE VOICEMAIL VOLTAGE DETECTION BY THE FSK DETECTION METHOD

1. Press ***7764#MUTE** on the handset to enter **ADMIN** mode.
2. Press **12**. Then, press a dialing key, **0** (disable) or **1** (enable), to select the desired setting. You hear 3 rising beeps as confirmation.

TO CHANGE THE VOICEMAIL VOLTAGE DETECTION BY THE PANASONIC DETECTION METHOD

1. Press ***7764#MUTE** on the handset to enter **ADMIN** mode.
2. Press **14**. Then, press a dialing key, **0** (disable) or **1** (enable), to select the desired setting. You hear 3 rising beeps as confirmation.





TO CHANGE THE VOICEMAIL VOLTAGE DETECTION BY THE SIEMENS DETECTION METHOD

1. Press ***7764#MUTE** on the handset to enter **ADMIN** mode.
2. Press **13**. Then, press a dialing key, **0** (disable), **1** (50Hz), **2** (25Hz), or **3** (20Hz), to select the desired setting. You hear 3 rising beeps as confirmation.





SPEED DIAL KEYS

This telephone has up to 8 programmable guest-service (Speed Dial) keys. Program these keys to automatically dial telephone numbers or to activate telephone system features.

EXAMPLES FOR CTM-A2415

Speed dial key	Faceplate with Speed dial key	Speed dial value (default)
SPD5	FRONT DESK 	24106
SPD6	ROOM SERVICE 	24107
SPD7	MESSAGE 	24111
SPD8	EMERGENCY 	24105

EXAMPLES FOR CTM-A2415HC

Speed Dial keys	Sticker for Speed dial key	Speed dial value (default)
SPD1	FRONT DESK 	24106
SPD2	ROOM SERVICE 	24107
	EMERGENCY 	24105
	MESSAGES 	24111

TO PROGRAM A SPEED DIAL KEY

1. Press ***234636#MUTE** on the handset to enter **SPEED DIAL PROGRAMMING** mode. You hear 3 beeps while **MUTE** key (on handset) and all LEDs (on base) are flashing.
2. Press the desired Speed Dial key where the telephone number is to be stored.
3. Enter the telephone number (up to 32 digits). Press the same Speed Dial key to confirm. You hear 3 rising beeps as confirmation.
 - To insert a pause in the stored number, press the **SPEAKER** key on the handset.
 - The telephone can store maximum 32 digits.
4. To program other Speed Dial keys, repeat steps 2 and 3.
5. Press **OFF** key to quit **SPEED DIAL PROGRAMMING** mode.

TO CLEAR THE PROGRAMMED SPEED DIAL KEY

1. Press ***234636#MUTE** on the handset to enter **SPEED DIAL PROGRAMMING** mode.
2. Press the Speed Dial key twice where the telephone number is to be deleted. You hear 3 rising beeps as confirmation.

Operation

Cordless 1-line - CTM-A2415

Cordless Accessory Handset & Charging stand - CTM-A2415HC

USING THE CORDLESS HANDSET AND THE TELEPHONE BASE

The cordless handset and the telephone base cannot be used on the same call. However, calls can be switched between the cordless handset and the telephone base speakerphone.

When the cordless handset or the telephone base is in use, the **TALK** key on the cordless handset or the **SPEAKER** LED on the telephone base illuminate.

RECEIVE A CALL

The telephone rings when there is an incoming call. The **MESSAGE WAITING** LEDs flash.

ANSWER A CALL USING THE CORDLESS HANDSET WHILE IT IS NOT ON THE TELEPHONE BASE OR CHARGING BASE

On the cordless handset, press **TALK** or **SPEAKER**.

- The **TALK** key illuminates when in use. The **SPEAKER** key illuminates when in speakerphone mode.

ANSWER A CALL USING THE CORDLESS HANDSET WHILE IT IS CRADLED ON THE TELEPHONE BASE OR CHARGING BASE

Lift the cordless handset from the telephone base or charging base.

- The **TALK** key illuminates when in use. The **SPEAKER** key illuminates when in speakerphone mode.

ANSWER A CALL USING THE TELEPHONE BASE

On the telephone base, press **SPEAKER**.

- The **SPEAKER** key illuminates when in use.

PLACE A CALL

PLACE A CALL USING THE CORDLESS HANDSET

On the cordless handset, press **TALK** or **SPEAKER**. Listen for a dial tone and then dial the desired number, or press a Speed Dial key on the telephone base to dial a programmed number.

- The **TALK** key illuminates when in use. The **SPEAKER** key illuminates when in speakerphone mode.

PLACE A CALL USING THE TELEPHONE BASE

On the telephone base, press **SPEAKER**. Listen for a dial tone and then press a Speed Dial key on the telephone base to dial a programmed number.

- The **SPEAKER** key illuminates when in use.

END A CALL

END A CALL WHEN USING THE CORDLESS HANDSET

Press **OFF** on the cordless handset or place it in the telephone base or charging base. The call ends when all handsets hang up.

END A CALL WHEN USING THE TELEPHONE BASE

Press **SPEAKER**.

SWITCH A CALL BETWEEN THE CORDLESS HANDSET AND THE TELEPHONE BASE SPEAKERPHONE

- To switch a call from the cordless handset to the telephone base speakerphone, press **SPEAKER** on the telephone base.

- To switch a call from the telephone base speakerphone to the cordless handset which is not on the telephone base cradle, press **TALK** or **⏸**/ **SPEAKER** on the cordless handset.
- To switch a call from the telephone base speakerphone to the cordless handset which is cradled on the telephone base, lift the cordless handset from the telephone base.

SHARE A CALL

A maximum of four cordless handsets can be used at the same time on an external call.

JOIN A CALL

During a call, press **TALK** or **⏸**/ **SPEAKER** on another cordless handset to join.

HANDSET SPEAKERPHONE

During a call, press **⏸**/ **SPEAKER** on the cordless handset to switch between speakerphone mode and handset earpiece mode.

VOLUME

Listening volume can be adjusted on the cordless handset and the telephone base.

ADJUST THE LISTENING VOLUME

- During a call on the handset, press **-VOLUME+** on it to adjust the listening volume. The next call returns to the default listening volume.
- During a call on the telephone base, press **VOL+** and **VOL-** to adjust the listening volume. The next call returns to the default listening volume.

ADJUST THE RINGER VOLUME OF THE TELEPHONE BASE

Ringer volume of the telephone base can be adjusted. When the telephone base is idle, press **VOL+** and **VOL-** to adjust the ringer volume.

CALL WAITING

1. When you hear a call waiting tone during a call, press **TALK** on the cordless handset or the telephone base to put the current call on hold and take the new incoming call.
2. Press **TALK** at any time to switch back and forth between calls.

MUTE

MUTE THE MICROPHONE

1. During a call, press **MUTE** on the cordless handset or the telephone base.
 - The **MUTE** key illuminates when the mute function is turned on. You can hear the party on the other end but they cannot hear you.
2. Press **MUTE** again to resume the conversation.
 - The light on the **MUTE** key turns off.

FIND HANDSET

Use this feature to find all registered cordless handsets.

START PAGING

Press **FIND HS** (FIND HANDSET) on the telephone base when the telephone is not in use. All idle cordless handsets beep for 60 seconds.

END PAGING

- Press **FIND HS** (FIND HANDSET) again on the telephone base; or
- Press any key on the cordless handset to stop the paging tone.

Appendix

CTM-A2415 Base backup battery

It takes up to 12 hours for the battery to be fully charged. When the base experiences a power cut, you can expect the following performance:

OPERATION	OPERATING TIME
While in handset use (talking*)	Up to 90 minutes
While in speakerphone mode on the telephone base (talking*)	Up to 30 minutes
While not in use (standby**)	Up to 90 minutes

* Operating times vary depending on your actual use and the age of the battery.

** Base is not charging or in use.

The battery needs charging when:

- A new battery is installed in the base.

The battery needs replacement when:

- **REPLACE BATTERY** LED illuminates on the base.

CTM-A2415HC Handset battery

It takes up to 12 hours for the battery to be fully charged. When it is fully charged, you can expect the following performance:

OPERATION	OPERATING TIME
While in handset use (talking*)	Up to 7 hours
While in speakerphone mode (talking*)	Up to 5 hours
While not in use (standby**)	Up to 7 days

* Operating times vary depending on your actual use and the age of the battery.

** Handset is not charging or in use.

The battery needs charging when:

- A new battery is installed in the handset.
- **LOW BATTERY** LED illuminates on the cordless handset.

Appendix

Troubleshooting

If you have difficulty with the telephones, please try the suggestions below. For customer service, visit our website at www.vtechhotelphones.com or call 1-888-907-2007.

FOR CORDLESS TELEPHONE

QUESTION	SUGGESTIONS
The telephone does not work at all.	<ul style="list-style-type: none">• Make sure the power adapter is securely plugged into an outlet not controlled by a wall switch.• Make sure the telephone line cord is plugged firmly into the power adapter and the telephone wall jack.• Make sure the battery is installed and charged correctly (page 12-14). For optimum daily performance, return the cordless handset to the telephone base or charging base after use.• Unplug the electrical power to the telephone base. Wait for approximately 15 seconds, then plug it back in. Allow up to one minute for the cordless handset and the telephone base to synchronize.• Charge the battery in the cordless handset for up to 12 hours.• If the battery is completely depleted, charge the cordless handset for at least 30 minutes before use.• Remove the battery and then install it again. If that still does not work, it may be necessary to purchase a new battery.• Disconnect the telephone base from the telephone wall jack and plug in a working telephone. If the other telephone does not work, the problem is probably in the wiring or telephone service. Contact your telephone service provider (charges may apply).

QUESTION

SUGGESTIONS

There is no dial tone.

- Try all the above suggestions.
- Make sure there is a dial tone before dialing. It is normal if the cordless handset takes a second or two to synchronize with the telephone base before producing a dial tone. Wait an extra second before dialing.
- Eliminate any background noise. Mute the telephone before dialing, if applicable, or dial from another room in your unit with less background noise.
- If other telephones in your hotel are having the same problem, the problem is in the wiring or telephone service. Contact your telephone service provider (charges may apply).

I cannot dial out.

- Try all the above suggestions.
- Make sure there is a dial tone before dialing.
- Eliminate any background noise. Mute the telephone before dialing, if applicable, or dial from another room in your unit with less background noise.
- If other telephones in your hotel are having the same problem, the problem is in the wiring or telephone service. Contact your telephone service provider (charges may apply).

The **LOW BATTERY** LED illuminates on the cordless handset.

- Place the cordless handset in the telephone base or charging base for recharging.
- Remove the battery and then install it again, and use it until fully depleted. Then charge the cordless handset in the telephone base or charging base for up to 12 hours.
- If the above measures do not correct the problem, replace the battery.

QUESTION

The battery does not charge in the cordless handset or the battery does not accept charge.

The **CHARGE** LED is off.

SUGGESTIONS

- Make sure the cordless handset is placed in the telephone base or charging base correctly. The **CHARGE** LED should be on.
 - Remove the battery and then install it again. Charge it for up to 12 hours.
 - If the cordless handset is in the telephone base or charging base but the **CHARGE** LED is not on, refer to **The CHARGE LED is off** below.
 - If the battery is completely depleted, charge the cordless handset for at least 30 minutes before use.
 - If the above measures do not correct the problem, replace the battery.
-
- Clean the charging contacts on the cordless handset, telephone base and charging base each month with a pencil eraser or a dry non-abrasive fabric.
 - Make sure the power adapter and telephone line cord are plugged in correctly and securely.
 - Unplug the power adapter. Wait for 15 seconds before plugging it back in. Allow up to one minute for the cordless handset and the telephone base to reset.
-

The telephone does not ring when there is an incoming call.

- Make sure the telephone line cord and the power adapter are plugged in properly (page 13-14).
- The cordless handset may be too far from the telephone base. Move it closer to the telephone base.
- Adjust the setting of RF transmission power (page 16). It may be out of range.
- If other telephones in your hotel are having the same problem, the problem is in the wiring or telephone service. Contact your telephone service provider (charges may apply).
- Other electronic products such as HAM radios and other DECT phones can cause interference with the cordless phone. Try installing the phone as far away as possible from these types of electronic devices.
- Test a working telephone at the telephone wall jack. If the other telephone has the same problem, the problem is in the telephone wall jack. Contact your telephone service provider (charges may apply).
- The telephone line cord may be defective. Install a new telephone line cord.
- Remove the battery and then install it again. Then place the cordless handset in the telephone base. Wait for the handset to synchronize with the telephone base. Allow up to one minute for this to take place.

QUESTION

The cordless handset beeps and is not performing normally.

SUGGESTIONS

- Make sure the power cord is securely plugged into the telephone base. Plug the telephone base into a different working electrical outlet not controlled by a wall switch.
 - Move the cordless handset closer to the telephone base or adjust the setting of RF transmission power (page 16). It may be out of range.
 - Reset the telephone base by unplugging the electrical power to the base. Wait for 15 seconds and plug it back in again. Allow up to one minute for the cordless handset and the telephone base to synchronize.
 - Other electronic products such as HAM radios and other DECT phones can cause interference with the cordless phone. Try installing the phone as far away as possible from these types of electronic devices.
-

There is interference during a telephone conversation, or the call fades in and out when I am using the cordless handset.

- Move the handset closer to the telephone base or adjust the setting of RF transmission power (page 16). It may be out of range.
- If there is High Speed Internet Access (HSIA) available at the premises through a telephone line, you may need to install a DSL filter (DSL - digital subscriber line) between the telephone line cord and the telephone wall jack. The filter prevents noise and caller ID problems caused by DSL interference. Contact your DSL service provider for more information about DSL filters.
- Appliances or other cordless telephones plugged into the same circuit as the telephone base can cause interference. Try moving the appliance or the telephone base to another outlet.
- Other electronic products such as HAM radios and other DECT phones can cause interference with the cordless phone. Try installing the phone as far away as possible from these types of electronic devices.
- If the telephone is plugged in with a modem or a surge protector, plug the telephone (or modem/surge protector) into a different location. If this doesn't solve the problem, relocate the telephone or modem farther apart from each other, or use a different surge protector.
- The location of the telephone base can impact the performance of the cordless phone. For better reception, install the telephone base in a centralised location within the room, away from walls or other obstructions.
- Disconnect the telephone base from the telephone wall jack and plug in a corded telephone. If calls are still not clear, the problem is probably in the wiring or telephone service. Contact your telephone service provider (charges may apply).

QUESTION	SUGGESTIONS
There is interference during a telephone conversation, or the call fades in and out when I am using the cordless handset.	<ul style="list-style-type: none"> • If other telephones in your hotel are having the same problem, the problem is in the wiring or telephone service. Contact your telephone service provider (charges may apply).
I hear other calls when using the telephone.	<ul style="list-style-type: none"> • Disconnect the telephone base from the telephone wall jack. Plug in a different telephone. If you still hear other calls, the problem is probably in the wiring or telephone service. Contact your telephone service provider (charges may apply).
I hear noise on the cordless handset and the keys do not work.	<ul style="list-style-type: none"> • Make sure the telephone line cord is plugged in securely.
Reset instructions for common issues.	<ul style="list-style-type: none"> • If the telephone is not responding normally, put the cordless handset in the telephone base. If it does not fix the problem, try the following (in the order listed): <ol style="list-style-type: none"> 1. Disconnect the power to the telephone base. 2. Disconnect the battery on the cordless handset. 3. Wait a few minutes before connecting power to the telephone base. 4. Install the battery again and then place the cordless handset in the telephone base. 5. Wait for the cordless handset to synchronize with the telephone base. Allow up to one minute for this to take place.

Appendix

VTech Hospitality Limited Warranty Program

VTech Telecommunications Ltd., the manufacturer of VTech Hospitality Product ("Product"), warrants to the holder of a valid proof of purchase ("end user" or "you") that the Product and all accessories provided by VTech in the Product's package are free from defects in material and workmanship, pursuant to the following terms and conditions, when installed and used normally and in accordance with the Product's operating instructions. The limited warranty extends to the end user of this Product and applies only if such Product is purchased through a United States of America and/or Canadian distributor. The limited warranty period for this Product is determined based on the following:

5 YEARS – ANALOG MODELS

- All Classic Models – corded and cordless
- All Contemporary Models – corded and cordless
- All TrimStyle Models

2 YEARS – SIP NON-DISPLAY MODELS

- All Classic Models – corded and cordless
- All Contemporary Models – corded and cordless
- All TrimStyle Models

During the limited warranty period, VTech's authorised service representative will repair or replace, at VTech's option, without charge, a Product that is not free from defects in materials and workmanship. If VTech's authorised service representative repairs the Product, new or refurbished replacement parts may be used. If the Product is replaced, it may be replaced with a new or refurbished Product of the same or similar design. Repair or replacement of Product, at VTech's option, is the exclusive remedy.

The limited warranty period for the Product begins on the date that the end user takes possession of the Product. This limited warranty also applies to repaired or replacement Products for a period of either: (a) 90 days from the date the repaired or replacement Product is shipped to you; or (b) the time remaining on the original limited warranty as described above; whichever is longer.

This limited warranty does not cover:

1. Product or parts that have been subjected to misuse, accident, shipping or other physical damage, improper installation, abnormal operation or handling, neglect, inundation, fire, water or other liquid intrusion; or
2. Product that has been damaged due to repair, alteration or modification by anyone other than an authorised service representative of VTech; or
3. Product to the extent that the problem experienced is caused by signal conditions, network reliability or cable or antenna systems; or

4. Product to the extent that the problem is caused by use with non-VTech accessories; or
5. Product whose warranty/quality stickers, product serial number plates or electronic serial numbers have been removed, altered or rendered illegible; or
6. Product purchased, used, serviced, or shipped for repair from outside the United States or Canada, or used for non-approved commercial or institutional purposes (including but not limited to Products used for rental purposes); or
7. Product returned without valid proof of purchase; or
8. Charges or costs incurred by the end user, and risk of loss or damage, in removing and shipping the Product, or for installation or set up, adjustment of customer controls, and installation or repair of systems outside the unit.
9. Line cords or coil cords, plastic overlays, connectors, power adapters and batteries, if the Product is returned without them. VTech will charge the end user at then-current prices for each of the missing items.
10. NiCd or NiMH handset batteries, or power adapters, which, under all circumstances, are covered by a one (1) year warranty only.

Except as provided by applicable law, you assume the risk of loss or damage during transit and transportation and are responsible for delivery or handling charges incurred in the transport of Product(s) to the service location. VTech's authorised service representative will return repaired or replaced product under this limited warranty to you, transportation, delivery and handling charges prepaid. VTech assumes no risk for damage or loss of the Product in transit.

If the Product failure is not covered by this limited warranty, or proof of purchase does not meet the terms of this limited warranty, VTech will notify you and will request that you authorize the cost of repair and return shipping costs for the repair of Products that not covered by this limited warranty. You must pay for the cost of repair and return shipping costs for the repair of Products that are not covered by this limited warranty.

OTHER LIMITATIONS

This warranty is the complete and exclusive agreement between you and VTech. It supersedes all other written or oral communications related to this Product. VTech provides no other warranties for this Product, whether express or implied, oral or written, or statutory. The warranty exclusively describes all of VTech's responsibilities regarding the Product. No one is authorised to make modifications to this warranty and you should not rely on any such modification.

VTech's liability to end user hereunder shall not exceed the purchase price of the Product. In no event shall VTech be liable for any indirect, special, incidental, consequential, or similar damages (including, but not limited to lost profits or revenue, inability to use the product, or other associated equipment, the cost of substitute equipment, and claims by third parties) resulting from the use of this Product. Some states/provinces do not allow the exclusion or limitation of incidental or consequential damages, so the above limitation or exclusion may not apply to you.

This warranty gives you specific legal rights, and you also have other rights which vary from state to state or province to province.

Appendix

Energy-saving charging mode

When this mode is activated, all telephone functions, except handset battery charging, will be disabled.

TO ACTIVATE THE ENERGY-SAVING CHARGING MODE IN A2415/A2415HC:

1. Unplug the telephone base backup battery or press switch to shut down the backup battery. Unplug the power adapter from the power outlet. Unplug the telephone line cord from the telephone wall jack.
 - Make sure all handsets are plugged with charged batteries before proceeding.
2. While you press and hold  /**FIND HANDSET**, plug the telephone base power back to the power outlet.
3. After about 20 seconds, when the **IN USE** light starts flashing, release  /**FIND HANDSET** and then press it again within 2 seconds. When the telephone base successfully enters the energy-saving charging mode, all keys on the telephone base should not respond.
4. Press *331734# and then press **MUTE** to deregister each handset manually.

WHEN THE PHONE SUCCESSFULLY ENTERS THE ENERGY-SAVING MODE, THE **IN USE** LIGHT TURNS OFF AND YOU HEAR 3 RISING BEEPS.

WHEN THE PHONE FAILS TO ENTER THIS MODE, REPEAT STEP 1 THROUGH STEP 4 ABOVE.

NOTE

The telephone base will be powered up as normal if you fail to press  /**FIND HANDSET** within 2 seconds in Step 3.

TO DEACTIVATE THE ENERGY-SAVING CHARGING MODE:

Unplug the telephone base adapter from the power outlet. Then plug the telephone base power adapter and the telephone line cord back in. Then the telephone base is powered up as normal.

Register the handsets back to the telephone base. See page 14 for handset registration instructions.

Maintenance

TAKING CARE OF YOUR TELEPHONE

Your telephone contains sophisticated electronic parts, so it must be treated with care.

AVOID ROUGH TREATMENT

Place the handset down gently. Save the original packing materials to protect your telephone if you ever need to ship it.

AVOID WATER

Your telephone can be damaged if it gets wet. Do not use the handset outdoors in the rain, or handle it with wet hands. Do not install the telephone base near a sink, bathtub or shower.

ELECTRICAL STORMS

Electrical storms can sometimes cause power surges harmful to electronic equipment. For your own safety, take caution when using electrical appliances during storms.

CLEANING YOUR TELEPHONE

Your telephone has a durable plastic casing that should retain its luster for many years. Clean it only with a soft cloth slightly dampened with water or mild soap. Do not use excess water or cleaning solvents of any kind.

Disclaimer and Limitation of Liability

VTech Telecommunications Ltd. and its suppliers assume no responsibility for any damage or loss resulting from the use of this user's manual. VTech Telecommunications Ltd. and its suppliers assume no responsibility for any loss or claims by third parties that may arise through the use of this product. VTech Telecommunications Ltd. and its suppliers assume no responsibility for any damage or loss caused by deletion of data as a result of malfunction, dead battery, or repairs. Be sure to make backup copies of important data on other media to protect against data loss.

REMEMBER THAT ELECTRICAL APPLIANCES CAN CAUSE SERIOUS INJURY IF USED WHEN YOU ARE WET OR STANDING IN WATER. IF THE TELEPHONE BASE SHOULD FALL INTO WATER, DO NOT RETRIEVE IT UNTIL YOU UNPLUG THE POWER CORD AND/OR TELEPHONE LINE CORD FROM THE WALL. THEN REMOVE THE TELEPHONE BY THE UNPLUGGED CORDS.

European Directives

These equipments are compliant with 2014/53/EU (RED) and 2011/65/EU (ROHS).

Declaration of Conformity

The Declaration of Conformity may be obtained from: www.vtechhotelphones.com.



Disposal of batteries and product

These symbols (①, ②) on the products, packaging, and/or accompanying documents mean that used electrical and electronic products and batteries must not be

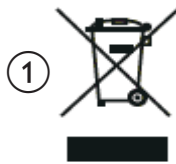

mixed with general household waste. For proper treatment, recovery and recycling of old products and batteries, please take them to applicable collection points in accordance with your national legislation.

By disposing of them correctly, you will help to save valuable resources and prevent any potential negative effects on human health and the environment.

For more information about collection and recycling, please contact your local municipality. Penalties may be applicable for incorrect disposal of this waste, in accordance with national legislation.

PRODUCT DISPOSAL INSTRUCTIONS FOR BUSINESS USERS

If you wish to discard electrical and electronic equipment, please contact your dealer or supplier for further information.

INFORMATION ON DISPOSAL IN OTHER COUNTRIES OUTSIDE THE EUROPEAN UNION

These symbols (①, ②) are only valid in the European Union. If you wish to discard these items, please contact your local authorities or dealer and ask for the correct method of disposal.



NOTE FOR THE BATTERY SYMBOL

This symbol (②) might be used in combination with a chemical symbol. In this case it complies with the requirement set by the Directive for the chemical involved.

Technical specification

Cordless 1-line - CTM-A2415

Cordless Accessory Handset & Charging Stand - CTM-A2415HC

Frequency control	Crystal controlled PLL synthesizer
Transmit frequency	Handset: 1881.792-1897.344 MHz Telephone base: 1881.792-1897.344 MHz
Channels	10
Nominal effective range	Actual operating range may vary according to environmental conditions at the time of use.
 Power requirement	Handset: 2.4V Ni-MH battery <ul style="list-style-type: none">• Corun 2.4V 550mAh Ni-MH AAA 550mAh 2.4V Telephone base backup battery: 2.4V Ni-MH battery <ul style="list-style-type: none">• Corun 2.4V 550mAh Ni-MH AAA 550mAh 2.4V Telephone base: 6V DC @450mA Charging stand: 6V DC @450mA <ul style="list-style-type: none">• Manufacturer: VTech Telecommunications Limited• Model identifier: VT05EUK06045(UK), VT05EEU0645(EU) Adaptor (AUS) Manufacturer: Ten Pao Industrial Co.,Ltd. Model identifier: S003IS0600045 (AUS)
RF output power	Maximum transmit power: 250mW / 24dBm  CAUTIONS To maintain the compliance with the RF exposure requirement, the Base Unit shall be installed and used such that parts of user's body other than hands are maintained at a distance of 20 cm or more.
Message waiting signal	Steady/periodic high voltage pulse, periodic low voltage pulse, reverse polarity, FSK, Siemens and/or Panasonic
Speed Dial memory	Telephone base: up to 4 memory locations; up to 32 digits Handset: up to 4 memory locations; up to 32 digits
Size	Telephone base: 2.93 x 5.67 x 5.39 in (74.5 x 144 x 137 mm) Handset: 1.89 x 8.27 x 1.57 in (48 x 210 x 40 mm) Charging stand: 2.76 x 3.78 x 4.17 in (70 x 96 x 106 mm)
Manufacturer	VTech Telecommunications Limited; Address: 23/F., Tai Ping Industrial Centre, Block 1, 57 Ting Kok Road Tai Po, HONG KONG
Importer	Refer and contact local importer/ distributor



Specifications are subject to change without notice.

VTech Telecommunications Inc.

All rights reserved. 10/20.

Near Terms Cordless_CTM2415-2415HC_CEC_AUS_201029